

226

H

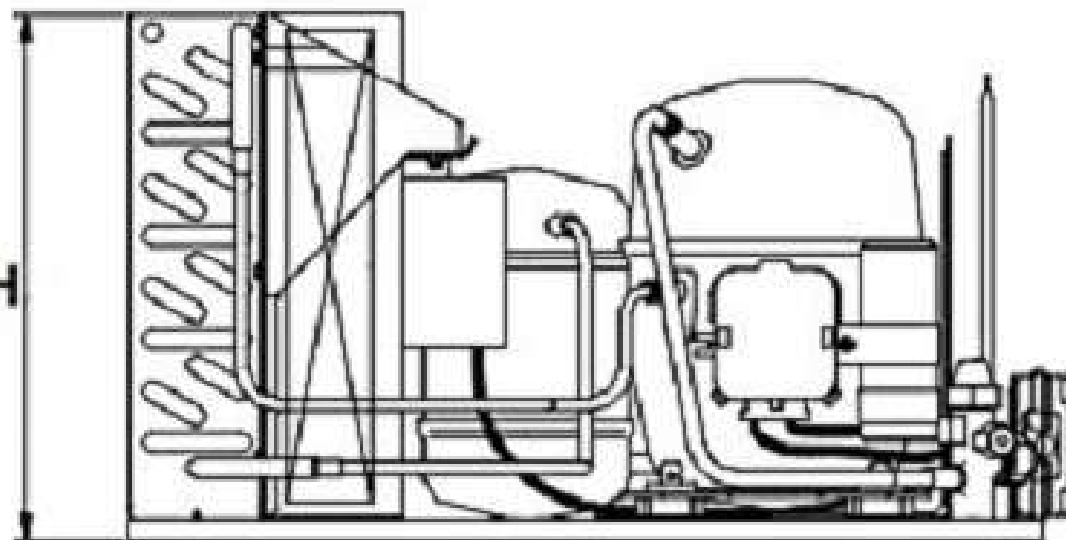

312

W

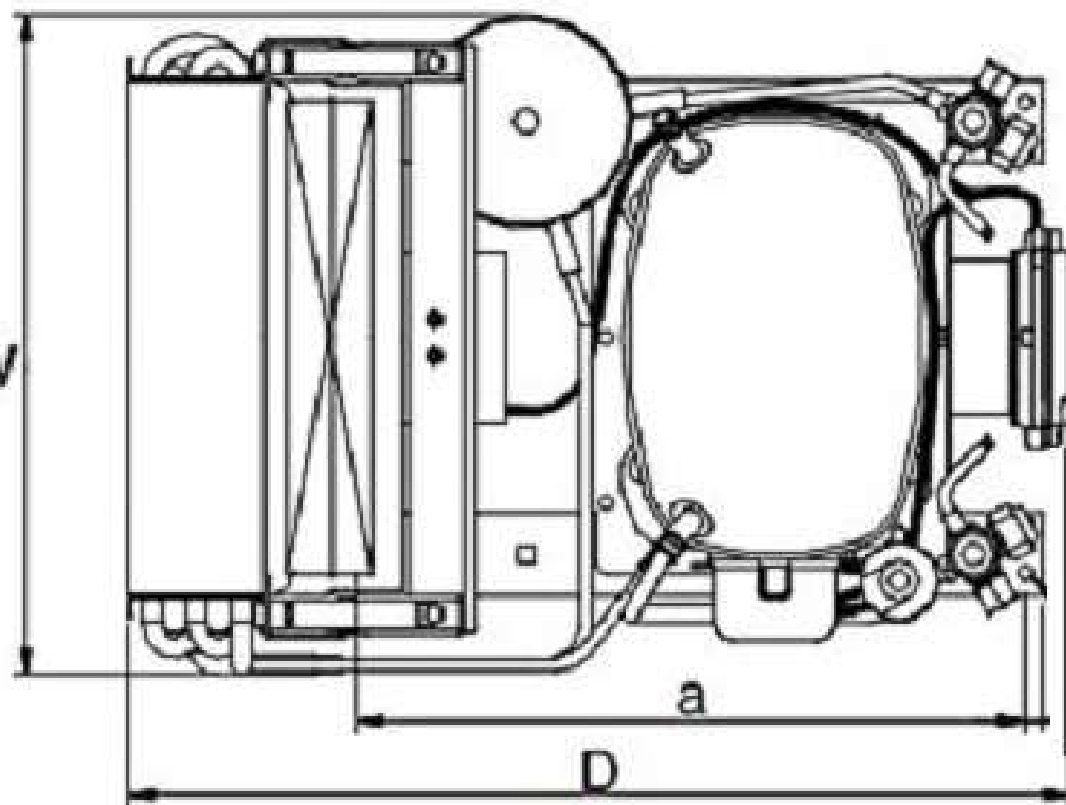

446